

REVISIONS				
ZONE	REV	DESCRIPTION	DATE	APPROVED

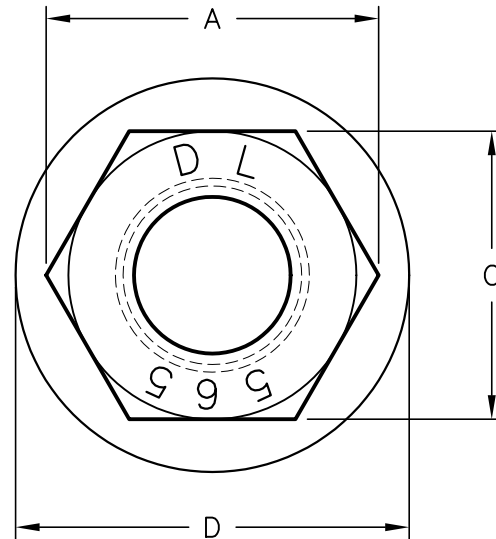

PART # NSF205-01-565	A IN.	B IN.	C IN.	D IN.
PART NAME 1/2"-20UNF DISC-LOCK NUT	.866 .840	.690 Ref.	.750 .736	.980 Ref.

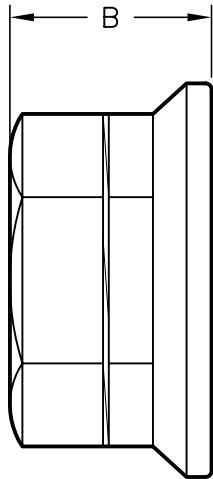

MATERIAL: 1035/45 STEEL

NOTES: HEAT TREATMENT HRC 28-36
COATING: MAGNI 565

NAME <i>DISC-LOCK Nut</i>			
SIZE A	FSCM NO.	DWG NO. NSF205-01-565	REV
SCALE N.T.S.	SHEET 1		